

Document Nr: IG30 (EN)	Issue date: 19.09.2019	Revision Nr./Date: 00/	Page/Total: 1/1
---------------------------	---------------------------	---------------------------	--------------------

QUICK INSTALLATION GUIDE

1

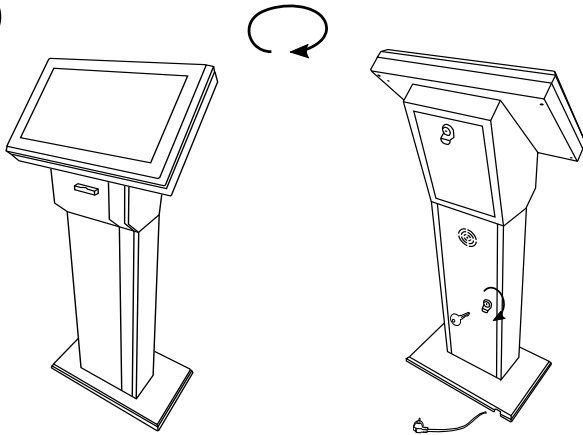

Open the bottom cover on the back of the device with the Q-smart ticket machine key.

2

Network connection

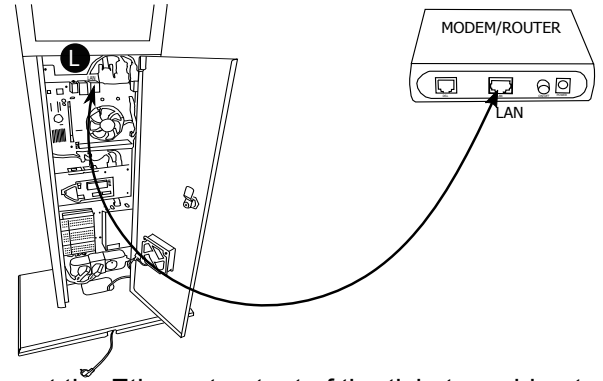

Connect the Ethernet output of the ticket machine to your modem, shown as (L) in the picture. You can find the IP address of the device on the screen when the application starting.

3

Hardware connection

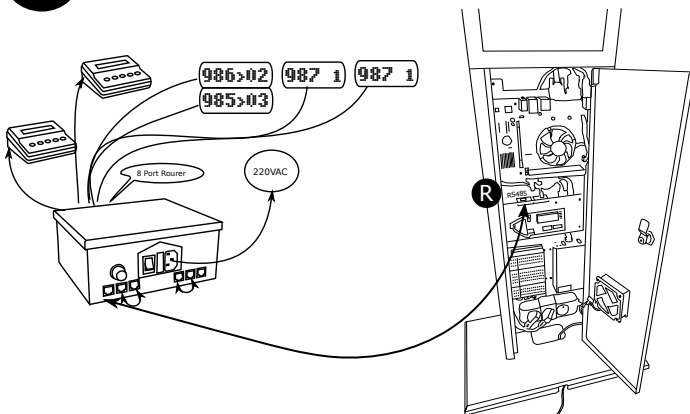

Connect the RS485 converter output of the ticket dispenser, shown with (R), to the Router with using the Q-smart hardware cable.

4

Power connection

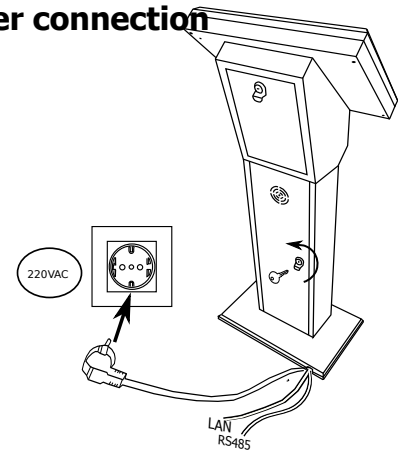

After making all connections, close the cover on the back of the device. Connect the device to 220V AC.

5

Paper loading

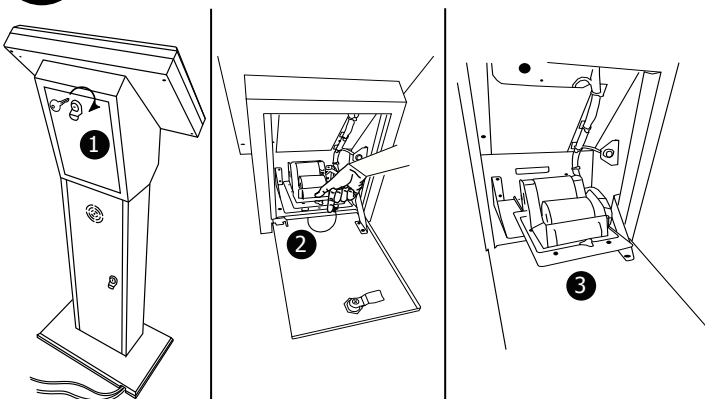

Open the top cover (1) with the Q-smart ticket machine key. Unscrew the screw in section (2) and pull the rail towards you. Load paper in section (3).

6

Operation

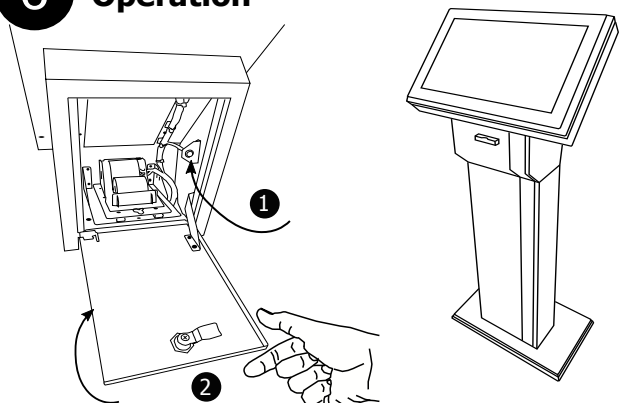

Push the printer rail forward and close the screw. Press the On/Off button (1) 1sec. Close the cover as shown in the picture (2) and lock the cover with Q-smart ticket machine key.